

SEMiX604GB126HDs

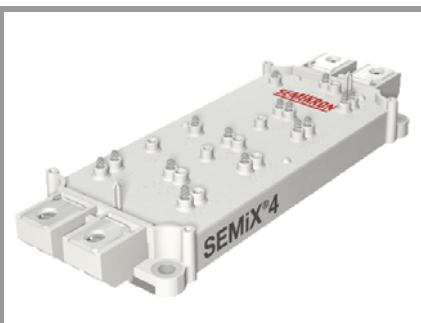

SEMiX[®]4s

Trench IGBT Modules

SEMiX604GB126HDs

Preliminary Data

Features

- Homogeneous Si
- Trench = Trenchgate technology
- $V_{CE(sat)}$ with positive temperature coefficient
- High short circuit capability
- UL recognised file no. E63532

Typical Applications

- AC inverter drives
- UPS
- Electronic Welding

Remarks

- Case temperature limited to $T_C=125^\circ\text{C}$ max.
- Not for new design

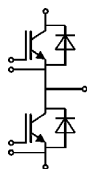

GB

Absolute Maximum Ratings					
Symbol	Conditions		Values	Unit	
IGBT					
V_{CES}			1200	V	
I_C	$T_j = 150^\circ\text{C}$	$T_c = 25^\circ\text{C}$	590	A	
		$T_c = 80^\circ\text{C}$	413	A	
I_{CRM}	$I_{CRM} = 2 \times I_{Cnom}$		800	A	
V_{GES}			-20 ... 20	V	
t_{psc}	$V_{CC} = 600\text{V}$ $V_{GE} \leq 20\text{V}$ $T_j = 125^\circ\text{C}$ $V_{CES} \leq 1200\text{V}$			10	μs
				-40 ... 150	$^\circ\text{C}$
T_j			-40 ... 150	$^\circ\text{C}$	
Inverse diode					
I_F	$T_j = 150^\circ\text{C}$	$T_c = 25^\circ\text{C}$	533	A	
		$T_c = 80^\circ\text{C}$	367	A	
I_{FRM}	$I_{FRM} = 2 \times I_{Fnom}$		800	A	
I_{FSM}	$t_p = 10\text{ms}$, half sine wave, $T_j = 25^\circ\text{C}$		2500	A	
T_j			-40 ... 150	$^\circ\text{C}$	
Module					
$I_{t(RMS)}$			600	A	
T_{stg}			-40 ... 125	$^\circ\text{C}$	
V_{isol}	AC sinus 50Hz, $t = 60\text{s}$		4000	V	

Characteristics						
Symbol	Conditions		min.	typ.	max.	Unit
IGBT						
$V_{CE(sat)}$	$I_{Cnom} = 400\text{A}$ $V_{GE} = 15\text{V}$ chiplevel	$T_j = 25^\circ\text{C}$		1.7	2.1	V
		$T_j = 125^\circ\text{C}$		2.00	2.45	V
V_{CE0}		$T_j = 25^\circ\text{C}$		1	1.2	V
		$T_j = 125^\circ\text{C}$		0.9	1.1	V
r_{CE}	$V_{GE} = 15\text{V}$	$T_j = 25^\circ\text{C}$		1.8	2.3	$\text{m}\Omega$
		$T_j = 125^\circ\text{C}$		2.8	3.4	$\text{m}\Omega$
$V_{GE(th)}$	$V_{GE}=V_{CE}$, $I_C = 16\text{mA}$		5	5.8	6.5	V
I_{CES}	$V_{GE} = 0\text{V}$ $V_{CE} = 1200\text{V}$	$T_j = 25^\circ\text{C}$		0.12	0.36	mA
		$T_j = 125^\circ\text{C}$				mA
C_{ies}	$V_{CE} = 25\text{V}$ $V_{GE} = 0\text{V}$	$f = 1\text{MHz}$		28.8		nF
C_{oes}		$f = 1\text{MHz}$		1.51		nF
C_{res}		$f = 1\text{MHz}$		1.31		nF
Q_G	$V_{GE} = -8\text{V} \dots +15\text{V}$			3200		nC
R_{Gint}	$T_j = 25^\circ\text{C}$			1.88		Ω
$t_{d(on)}$	$V_{CC} = 600\text{V}$			330		ns
t_r	$I_{Cnom} = 400\text{A}$ $T_j = 125^\circ\text{C}$			70		ns
E_{on}		$R_{G on} = 2.2\Omega$		36		mJ
$t_{d(off)}$		$R_{G off} = 2.2\Omega$		630		ns
t_f				130		ns
E_{off}				60		mJ
$R_{th(j-c)}$	per IGBT				0.065	K/W

SEMiX604GB126HDs

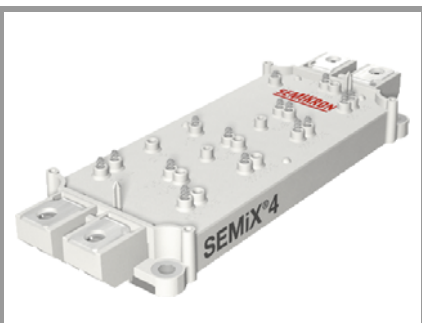

SEMiX[®]4s

Trench IGBT Modules

SEMiX604GB126HDs

Preliminary Data

Features

- Homogeneous Si
- Trench = Trenchgate technology
- $V_{CE(sat)}$ with positive temperature coefficient
- High short circuit capability
- UL recognised file no. E63532

Typical Applications

- AC inverter drives
- UPS
- Electronic Welding

Remarks

- Case temperatur limited to $T_C=125^\circ\text{C}$ max.
- Not for new design

Characteristics						
Symbol	Conditions		min.	typ.	max.	Unit
Inverse diode						
$V_F = V_{EC}$	$I_{Fnom} = 400\text{A}$ $V_{GE} = 0\text{V}$ chipllevel	$T_j = 25^\circ\text{C}$		1.6	1.8	V
		$T_j = 125^\circ\text{C}$		1.6	1.8	V
V_{F0}		$T_j = 25^\circ\text{C}$	0.9	1	1.1	V
		$T_j = 125^\circ\text{C}$	0.7	0.8	0.9	V
r_F		$T_j = 25^\circ\text{C}$	1.3	1.5	1.8	m Ω
		$T_j = 125^\circ\text{C}$	1.8	2.0	2.3	m Ω
I_{RRM}	$I_{Fnom} = 400\text{A}$	$T_j = 125^\circ\text{C}$		475		A
Q_{rr}	$di/dt_{off} = 6200\text{A}/\mu\text{s}$	$T_j = 125^\circ\text{C}$		100		μC
E_{rr}	$V_{GE} = -15\text{V}$ $V_{CC} = 600\text{V}$	$T_j = 125^\circ\text{C}$		46		mJ
$R_{th(j-c)D}$	per diode				0.11	K/W
Module						
L_{CE}				22		nH
$R_{CC'+EE'}$	res., terminal-chip	$T_C = 25^\circ\text{C}$		0.7		m Ω
		$T_C = 125^\circ\text{C}$		1		m Ω
$R_{th(c-s)}$	per module			0.03		K/W
M_s	to heat sink (M5)		3		5	Nm
M_t	to terminals (M6)		2.5		5	Nm
w					400	g
Temperature sensor						
R_{100}	$T_c=100^\circ\text{C}$ ($R_{25}=5\text{ k}\Omega$)			0,493 $\pm 5\%$		k Ω
$B_{100/125}$	$R_{(T)}=R_{100}\exp[B_{100/125}(1/T-1/T_{100})]$; $T[\text{K}]$;			3550 $\pm 2\%$		K

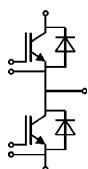

GB

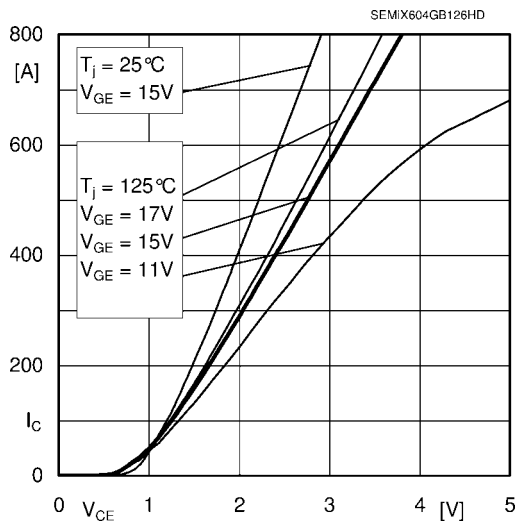

Fig. 1 Typ. output characteristic, inclusive $R_{CC'+EE'}$

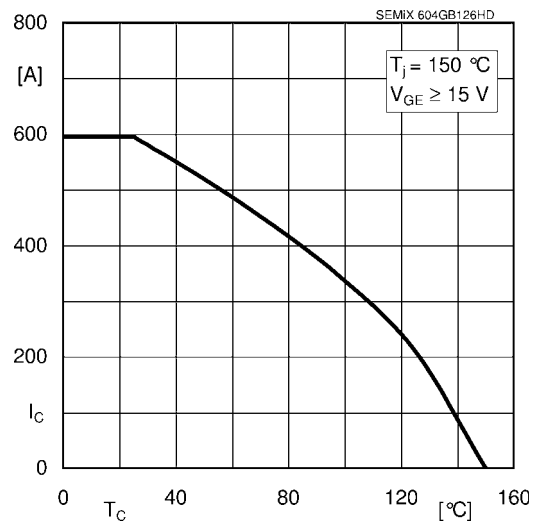

Fig. 2 Rated current vs. temperature $I_C = f(T_C)$

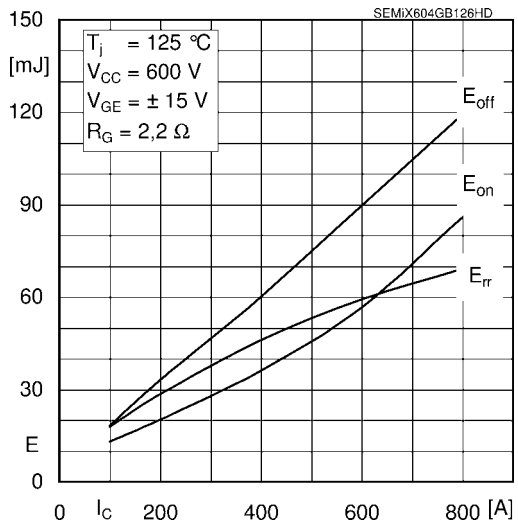

Fig. 3 Typ. turn-on /-off energy = $f(I_C)$

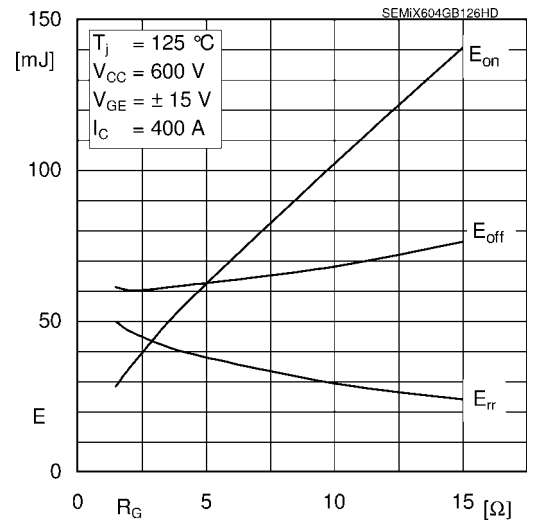

Fig. 4 Typ. turn-on /-off energy = $f(R_G)$

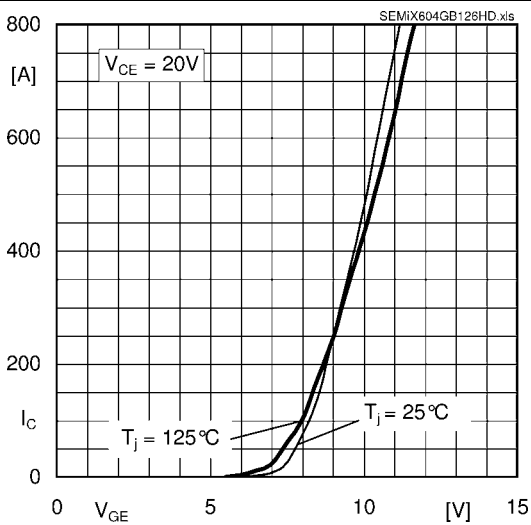

Fig. 5 Typ. transfer characteristic

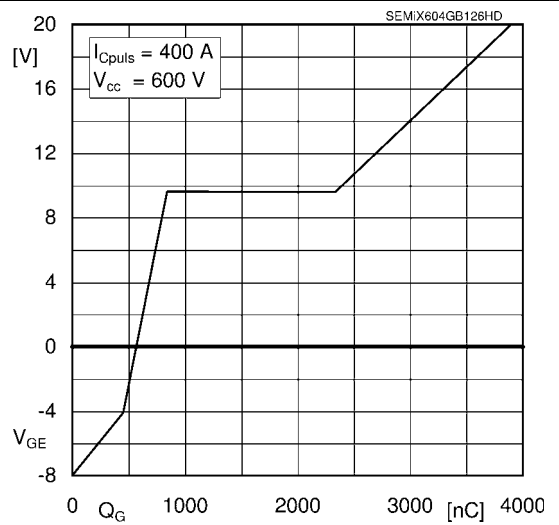

Fig. 6 Typ. gate charge characteristic

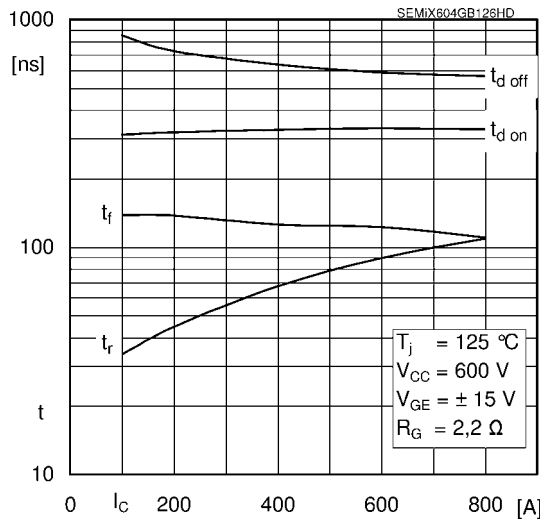

Fig. 7 Typ. switching times vs. I_C

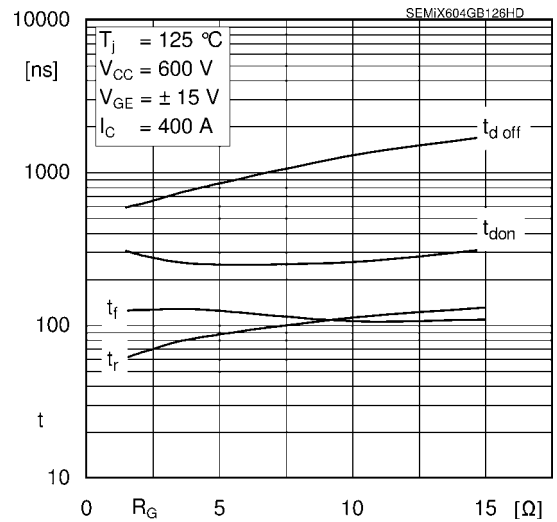

Fig. 8 Typ. switching times vs. gate resistor R_G

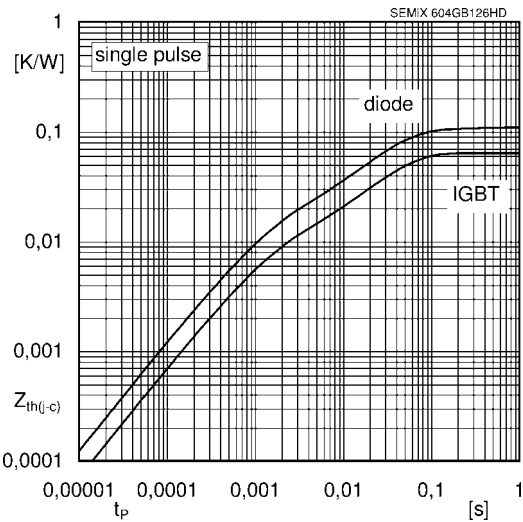

Fig. 9 Typ. transient thermal impedance

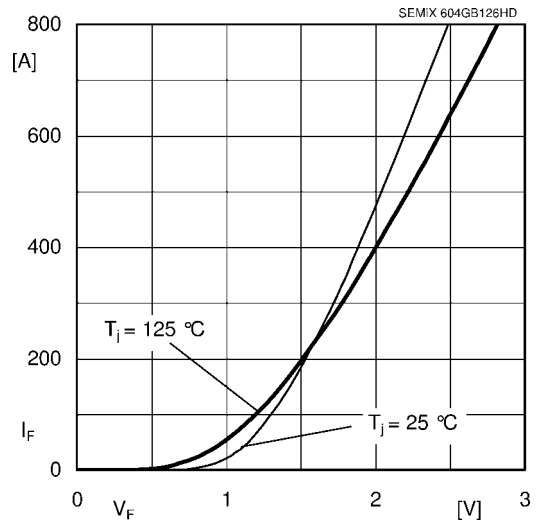

Fig. 10 Typ. CAL diode forward charact., incl. R_{CC+EE}

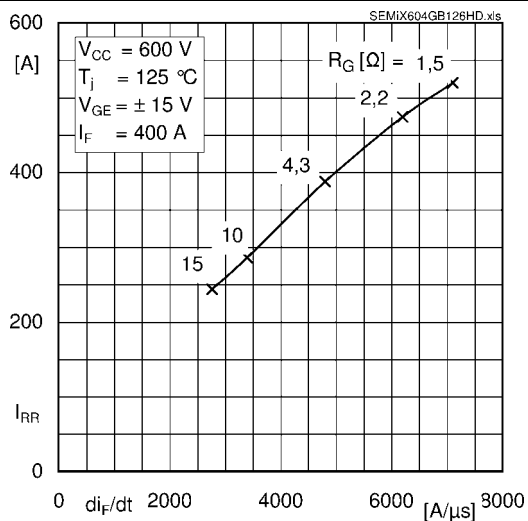

Fig. 11 Typ. CAL diode peak reverse recovery current

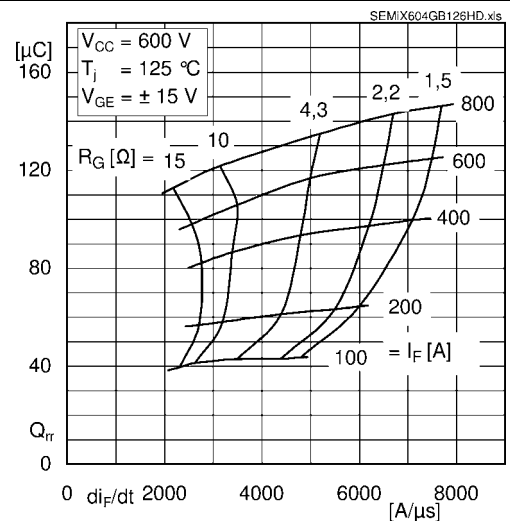
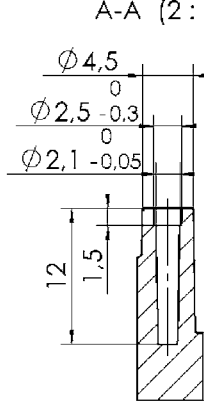

Fig. 12 Typ. CAL diode recovery charge

SEMiX604GB126HDs

case: SEMiX 4s

screw duct (4x):
A-A (2 : 1)



\square	0,3	main terminal +, - / ~, ~
//	0,2	A

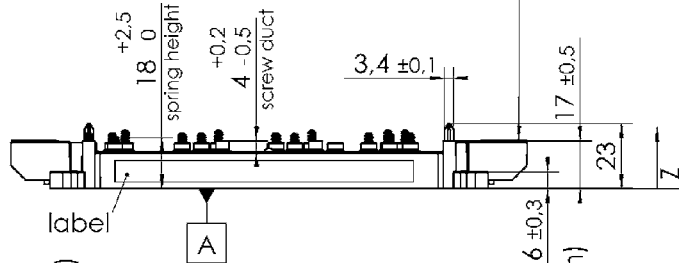

All measures in Z-direction
valid as mounted to heat sink

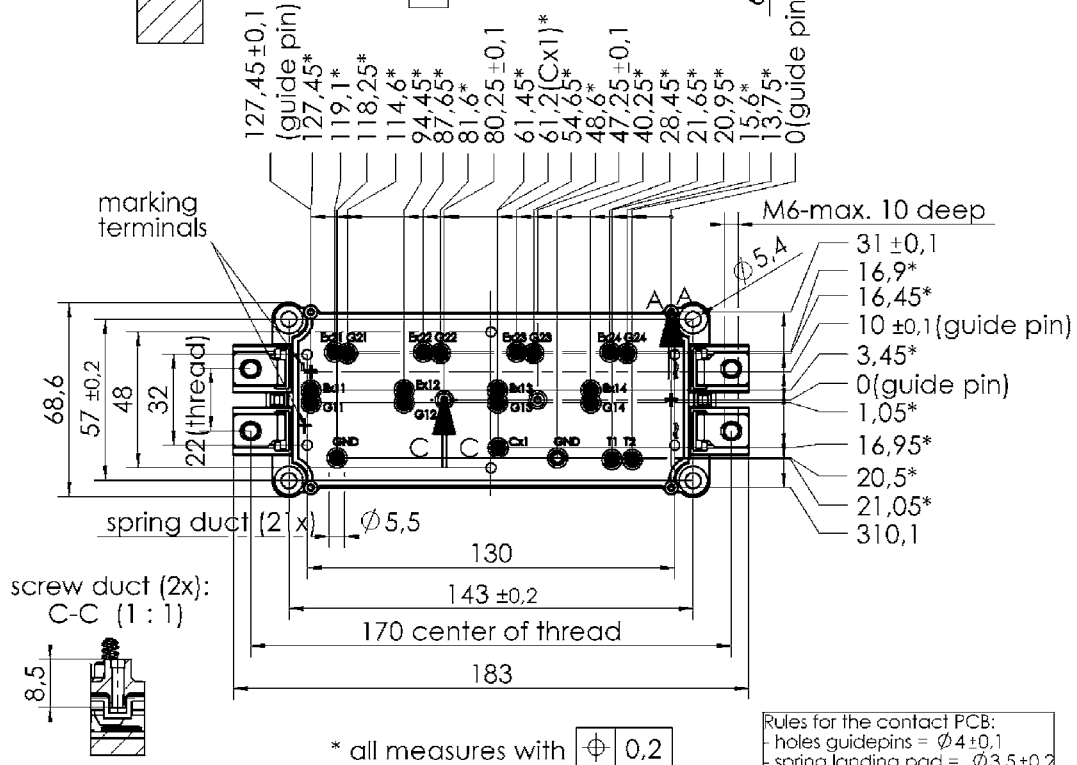

screw duct (2x):
C-C (1 : 1)

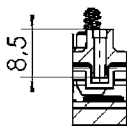

* all measures with $\pm 0,2$

Rules for the contact PCB:
- holes guidepins = $\varnothing 4 \pm 0,1$
- spring landing pad = $\varnothing 3,5 \pm 0,2$

SEMiX 4s

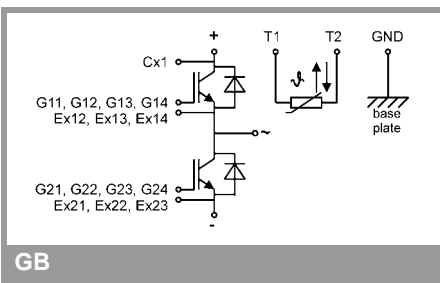

GB

This is an electrostatic discharge sensitive device (ESDS), international standard IEC 60747-1, Chapter IX

This technical information specifies semiconductor devices but promises no characteristics. No warranty or guarantee expressed or implied is made regarding delivery, performance or suitability.